

FIG. 6a

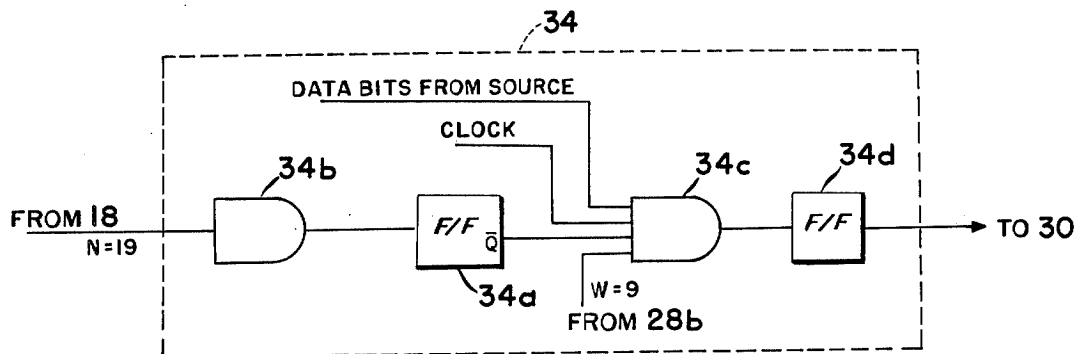

FIG. 6b

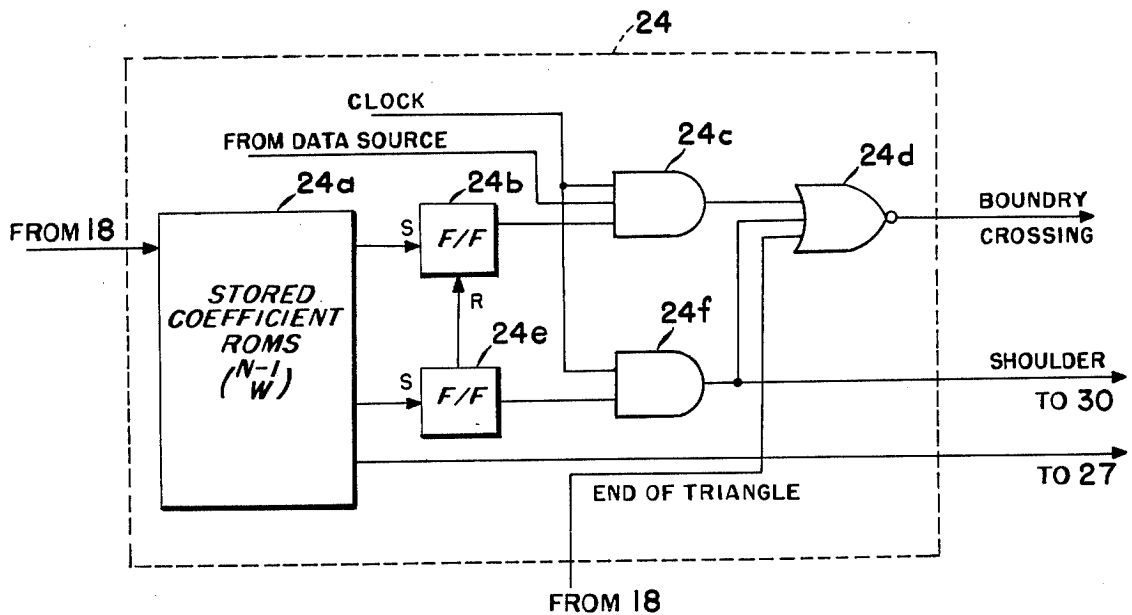

FIG. 6c